

Backwater lifting station Ecolift DN 150, Floor slab, tileable

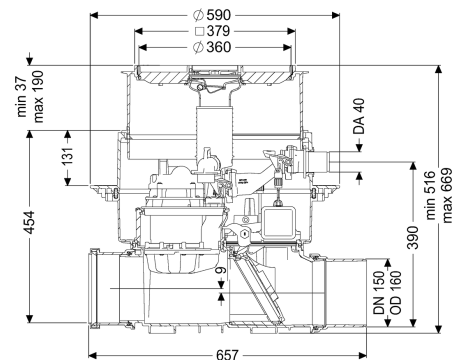

Article information

Item no.: 21150X
 GTIN: 4026092046869
 Price group: 20

Advantages

- Hybrid function: uses the natural fall to the sewer - pump is only used in case of backwater
- Quiet and energy-saving
- Double safety due to backwater flap and pressure loop

Description

The backwater lifting station for faecal and non-faecal wastewater is equipped with one pump and one motor-driven closure system. The pipe cross-section is normally open and the water drains to the sewer via natural fall. Backwater is detected by an optical probe, which causes the motor-driven closure system to close automatically. During the backwater phase, the water drains via a pressure pipe, which carries the wastewater above the backwater level and into the sewer. Connection hole in the drain body for installation in the ground, incl. seal for pressure pipe and cable conduit. The station is controlled by a user-friendly control unit, which is optionally integrated in the building management system via a potential-free contact, or alarm and collective fault messages can be output via a GSM interface.

Variant

Emergency closure:	yes
Passage seal for conduit pipe (DN):	50
Pump control:	Control unit
Protection class, probe:	IP 68 (3m/48h)
Motor-driven backwater flaps:	1

General characteristics

Colour:	black
Nominal size (DN):	150
Outer diameter (OD):	160 mm

Type of wastewater:	with sewage
Installation situation:	floor slab installation
Delivery state:	Pre-mounted for final assembly on site (pumps and sensor system must be fitted on site and control unit must be connected)
Approval:	Z-53.2-487
Motor type:	KSM 140
Type de protection moteur:	IP 68 (3m/48h)
Dimensions	
Net weight:	28 kg
Gross weight:	33,5 kg
Groundwater resistant from lower edge of base section:	3000 mm
Cutout dimension, width:	750 mm
Cutout dimension, length:	750 mm
Vertical drop between inlet and outlet:	9 mm
Installation depth:	516 - 669 mm
Type of height adjustability:	vertically adjustable upper section
Length:	656 mm
Width:	590 mm
Packaging dimension:	length
Packaging dimension:	width
Packaging dimension:	height
Tank/drain body	
Nominal pressure (PN):	6
Pressure pipe connection (OD):	40 mm
Socket version:	including spigot and socket
Coverage features	
Type of cover:	tileable cover plate
Cover material:	Polymer
Width of cover:	366 mm
Length of cover:	366 mm
Drainage function:	yes
Locking:	Lock & Lift
Load class:	K 3 (EN 1253-1)
Max. flooring height:	16 mm
Odour trap:	Multistop
Pumping device	
Pump:	SPZ 1000
Number of pumps:	1
Weight, pump:	10 kg
Connection type:	coded plug
Rated current:	5,2 A
Length of mains cable for pump:	5 m
Protection class:	I
Insulation class:	F

Cos phi - power factor:	0,97
Protection class (pump):	IP 68 (3m/48h)
Temperature monitoring:	integrated
Max. temperature (permanent) of conveyed material:	40 °C
Max. pumping capacity:	11,5 m ³ /h
Max. pumping height:	10 m
Speed:	2800 U/min
Power P1:	1,2 kW
Power P2:	0,69 kW
Operating mode:	S3 - 50 %
Type of fuse required (electrical protection):	C 16 A
Type of pump connection cable:	H07RN-F 3G 1.5 mm ²
Impeller type:	Macerator
Control	
Control unit:	Comfort
Standby power:	5 W
Alarm sensor:	optical probe
Level measurement instrument:	optical probe
Type of level measurement:	optical
Protection class control unit:	IP 54
Operating voltage:	230 V
Connection type:	coded plug
Length of mains cable for control unit:	1,4 m
Potential-free contact:	yes
GSM interface:	no
USB interface:	no
Log book function:	yes
Multi-line display:	yes
Battery buffering:	yes
Self-diagnosis system (SDS):	yes
Rated current:	5,2 A