

Box channel Ferrofix glued flange H: 15mm, 300x550mm

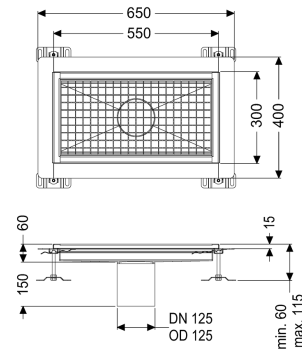

Article information

Item no.: 6030050
 GTIN: 4026092066478
 Price group: 80

Advantages

- Made of particularly a hygienic and mechanically highly resistant stainless steel
- Variably combinable with suitable drain bodies

Description

The Ferrofix box channel made of stainless steel with a material thickness of 2.0 mm (pickled in the immersion bath) is equipped with polished visible ridges, longitudinal and transverse slopes, feet for height adjustment and stainless steel outlet nozzles. The channel profile is suitable for joint sealing and has a circumferential adhesive edge (15 mm deep and 50 mm folded outwards) with welded mitres. The glued flange is suitable for connecting waterproofing layers in accordance with DIN 18534, for all waterproofing classes.

Variant

| | |
|--|--|
| Waterproofing layer on the upper section: | Adhesive flange (suitable for moisture barriers) |
| Water exposure class in accordance to DIN 18534-1 (up to and including): | W3-I |

General characteristics

| | |
|----------------------|--------|
| Nominal size (DN): | 125 |
| Outer diameter (OD): | 125 mm |
| Glued flange height: | 15 mm |

Dimensions

| | |
|----------------------|--------|
| Net weight: | 9 kg |
| Gross weight: | 9 kg |
| Length: | 550 mm |
| Width: | 300 mm |
| Height: | 60 mm |
| Packaging dimension: | length |

| | |
|-------------------------|--|
| Packaging dimension: | width |
| Packaging dimension: | height |
| Coverage features | |
| Type of cover: | Slotted cover |
| Colour of cover: | silver |
| Locking: | placed |
| Load class: | L 15 (EN 1253-1) |
| Slip resistance class: | R12 according to DIN 51130; C according to DIN 51097 |
| Upper section material: | Stainless steel 14301 |