

Ecolift XL backwater lifting st. Mono, 1 motor-driven flap, SPF 1500-S3

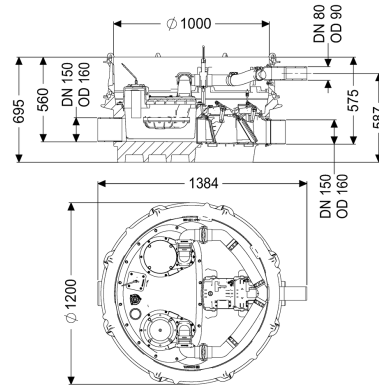

Article information

Item no.: 8741007
 GTIN: 4026092068243
 Price group: 60

Advantages

- Wastewater drainage without interruption, even if a power failure occurs, as long as there is no backwater
- low pump use
- minimised noise emissions

Description

The backwater lifting station for non-faecal wastewater is equipped with one submersible pump, one motor-driven and one mechanical closure system and a backflow preventer. The collection tank made of permanently resistant polymer (PE) has an enclosed pump tank. Quick-release closures enable the integrated components to be removed easily. Normally, draining takes place via the natural fall to the sewer. Backwater is detected by an optical probe, which causes the motor-driven closure system to close automatically and there is no longer free passage to the sewer. During the backwater phase, the water drains via a pressure pipe, which carries the wastewater into the sewer. The pressure pipe is a welded PE pipe; with pump SPF 4500, the pressure pipe must also be continued up to a pressure release chamber. The station is controlled by a user-friendly control unit, which is optionally integrated in the building management system via a potential-free contact, or alarm and collective fault messages can be output via a GSM interface. The KESSEL modular system provides different upper sections and engineering chamber options as accessories.

Variant

Note on installation depth:	Version for deeper installation
Type of system:	Single unit
Shut-off valve:	Shut-off valve made of polymer
Passage seal for conduit pipe (DN):	100

Passage seal for ventilation pipe (DN):	70
Pump control:	Control unit
Backflow preventer:	integrated
Pressure pipe connection:	horizontal
Motor-driven backwater flaps:	1
Mechanical backwater flaps:	1
General characteristics	
Colour:	black
Standard:	ÖNORM B 2501
Type of wastewater:	without sewage
Installation situation:	free-standing installation
Delivery state:	Pre-mounted for final assembly on site (pumps and sensor system must be fitted on site and control unit must be connected)
Backwater protection:	Type 3
Approval:	Z-53.2-493
ATEX:	no
Dimensions	
Net weight:	112,86 kg
Gross weight:	134,64 kg
Groundwater resistant from lower edge of base section:	3000 mm
Vertical drop between inlet and outlet:	15 mm
Length:	1384 mm
Width:	1200 mm
Height:	695 mm
Packaging dimension:	length
Packaging dimension:	width
Packaging dimension:	height
Tank/drain body	
Nominal pressure (PN):	10
Pressure pipe connection (DN):	80
Pressure pipe connection (OD):	90 mm
Channel:	continuous channel
Venting connection (DN):	70
Distance pipe bottom outlet to tank bottom:	120 mm
Distance pipe bottom inlet to tank bottom:	135 mm
Number of outlets:	1
Outlet nominal size (DN):	150 mm
Inlet nominal size (DN):	150 mm
Number of inlets:	1
Clear width of tank (LW):	1000 mm
Pumping volume:	20 l
Tank volume:	65 l
Pumping device	
Pump:	SPF 1500

Number of pumps:	1
Weight, pump:	24 kg
Connection type:	Direct connection
Rated current:	2,7 A
Protection class:	I
Insulation class:	F
Cos phi - power factor:	0,77
Protection class (pump):	IP 68 (3m/48h)
Temperature monitoring:	integrated
Max. temperature (permanent) of conveyed material:	40 °C
Max. pumping capacity:	28 m ³ /h
Max. pumping height:	7,5 m
Speed:	1415 U/min
Power P1:	1,4 kW
Power P2:	1,1 kW
Operating mode:	S3 - 50 %
Type of fuse required (electrical protection):	3 x C 16 A
Type of pump connection cable:	H07RN-F 7G 1.5 mm ²
Impeller type:	Multi-vane impeller
Free passage:	40 mm
Length of mains cable for pump:	10 m
Control	
Control unit:	Comfort Plus
Motor protection switch:	yes
Standby power:	5 W
Alarm sensor:	optical probe
Level measurement instrument:	Immersion pipe
Type of level measurement:	pneumatic
Protection class control unit:	IP 54
Operating voltage:	400 V
Connection type:	Direct connection
Potential-free contact:	yes
GSM interface:	yes
USB interface:	yes
Log book function:	yes
Multi-line display:	yes
Battery buffering:	yes
Self-diagnosis system (SDS):	yes
Type of fuse required (electrical protection):	3 x C 16 A