

## Pumping station Aquapump XL Duo, SPF 1500-S1

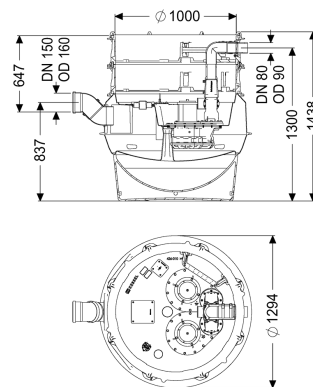

### Article information

Item no.: 8742009  
 GTIN: 4026092068649  
 Price group: 60

### Advantages

- Maximum safety
- Flexible installation
- Hygienic advantages for maintenance and repair

### Description

The pumping station for wastewater with and without sewage is equipped with one or two submersible pumps, a backflow preventer and a shut-off valve for the pressure pipe. The collection tank made of permanently resistant polymer (PE) has a closed pump tank (dry installation) with a screwed-on access cover. The station is controlled by a user-friendly control unit, which is optionally integrated in the building management system via a potential-free contact. Alternatively, alarm and collective fault messages can be output via a GSM interface. The KESSEL modular system provides different upper sections and engineering chamber options as accessories.

#### Variant

Note on installation depth:	Version for deeper installation
Type of system:	duo pump
Shut-off valve:	Shut-off valve made of polymer
Access steps:	yes
Installation:	Dry installation
Pump control:	Control unit
Backflow preventer:	integrated
Pressure pipe connection:	horizontal

#### General characteristics

Colour:	black
Standard:	EN 12050-1
Type of wastewater:	with sewage

Installation situation:	underground installation
Delivery state:	Pre-mounted for final assembly on site (pumps and sensor system must be fitted on site and control unit must be connected)
System type:	Duo
ATEX:	no
Dimensions	
Net weight:	211 kg
Gross weight:	235 kg
Groundwater resistant from lower edge of base section:	3000 mm
Length:	1295 mm
Width:	1295 mm
Height:	1403 mm
Packaging dimension:	length
Packaging dimension:	width
Packaging dimension:	height
Tank/drain body	
Pressure pipe connection (DN):	80
Pressure pipe connection (OD):	90 mm
Venting connection (DN):	70
Distance from centre of outlet pipe to tank bottom:	1300 mm
Distance pipe bottom inlet to tank bottom:	753 mm
Distance from centre of inlet pipe to tank bottom:	833 mm
Distance from inlet pipe invert to top of tank:	650 mm
Inlet nominal size (OD):	160 mm
Inlet nominal size (DN):	150 mm
Number of inlets:	1
Clear width of tank (LW):	1000 mm
Pumping volume:	160 l
Tank volume:	335 l
Pumping device	
Pump:	SPF 1500
Number of pumps:	2
Weight, pump:	27 kg
Connection type:	Direct connection
Rated current:	2,7 A
Protection class:	I
Insulation class:	F
Cos phi - power factor:	0,77
Protection class (pump):	IP 68 (3m/48h)
Temperature monitoring:	integrated
Max. temperature (permanent) of conveyed material:	40 °C
Max. pumping capacity:	40 m <sup>3</sup> /h

Max. pumping height:	8 m
Speed:	1415 U/min
Power P1:	1,4 kW
Power P2:	1,1 kW
Operating mode:	S1
Type of pump connection cable:	H07RN-F 7G 1.5 mm <sup>2</sup>
Impeller type:	Multi-vane impeller
Free passage:	40 mm
Length of mains cable for pump:	10 m
Control	
Control unit:	Comfort
Motor protection switch:	yes
Alarm sensor:	Immersion pipe
Level measurement instrument:	Immersion pipe
Type of level measurement:	pneumatic
Protection class control unit:	IP 54
Operating voltage:	400 V
Connection type:	Direct connection
Potential-free contact:	yes
GSM interface:	yes
Log book function:	yes
Multi-line display:	yes
Battery buffering:	yes
Self-diagnosis system (SDS):	yes