

## Grease separator EasyClean free NS 15, Direct, left

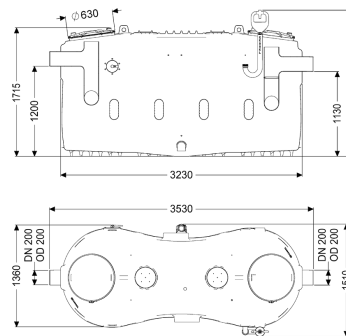

### Article information

Item no.: 93015-01-D-L

GTIN: 4026092105191

Price group: 60

### Advantages

- Direction of flow can be changed thanks to self-sealing interchangeable hubs (NS 2- NS 10)
- Low-maintenance operation
- Odour-reduced disposal with the tank closed

### Description

The separator for greasy wastewater is suitable for free-standing set-up in frost-protected rooms and comes without metallic components in the tank. The collecting tank made of permanently resistant polymer (PE) is equipped with an integrated sludge trap and has a tapered base for fast and clean disposal. Two odour-tight covers with quick-release closures make easy access possible for cleaning and maintenance work. A direct disposal pipe socket is available for odour-reduced manual disposal. After disposal, a maximum of 3 litres residual sludge volume is left in the tank. 20 year polyethylene warranty.

#### Variant

Direction of flow:	left
Shredder-Mix-System:	no
Sludge bucket:	no
Nominal size (NS):	15
SonicControl:	no
Refill inlet in accordance with DIN 1988:	no
Type of disposal:	manual

#### General characteristics

Material:	PE
Installation situation:	free-standing installation
Delivery state:	Installation-ready (connection parts must be connected on site)

Scope of delivery:	Storz-B coupling R 2 1/2" for disposal vehicle connection
<b>Dimensions</b>	
Net weight:	360 kg
Gross weight:	435 kg
Set-up area, length:	3530 mm
Set-up area, width:	1490 mm
Set-up area, height:	1950 mm
Packaging dimension:	length
Packaging dimension:	width
Packaging dimension:	height
<b>Tank/drain body</b>	
Nominal pressure (PN):	10
Pressure pipe connection (DN):	65
Pressure pipe connection (OD):	75 mm
Distance pipe bottom outlet to tank bottom:	1130 mm
Distance pipe bottom inlet to tank bottom:	1200 mm
Outlet nominal size (OD):	200 mm
Outlet nominal size (DN):	200 mm
Inlet nominal size (OD):	200 mm
Inlet nominal size (DN):	200 mm
Connection inlet/outlet sockets:	PE-HD pipes in accordance with DIN 19537, HT pipes in accordance with DIN 19560, PP or AS
Servicing opening:	420 mm
<b>Coverage features</b>	
Type of cover:	Cover
Cover material:	Polymer
Colour of cover:	violet
Locking:	Quick-release closure
Tightness:	odour-tight
<b>Wastewater contents</b>	
Separator contents:	2230 l
Total volume:	3730 l
Storage quantity of grease:	600 l
<b>Control</b>	
Control unit:	no