

Grease separator EasyClean free NS 15, Standard, left

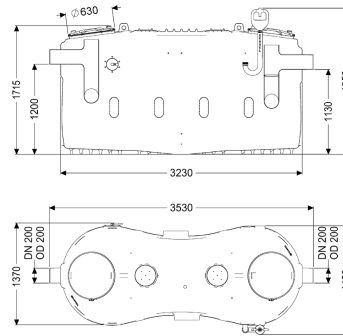

Article information

Item no.: 93015-01-L
 GTIN: 4026092105238
 Price group: 60

Advantages

- Direction of flow can be changed thanks to self-sealing interchangeable hubs (NS 2- NS 10)
- Can be retrofitted up to Auto Mix & Pump
- Low-maintenance operation

Description

The separator for greasy wastewater is suitable for free-standing set-up in frost-protected rooms and comes without metallic components in the tank. The collecting tank made of permanently resistant polymer (PE) is equipped with an integrated sludge trap and has a tapered base for fast and clean disposal. Two odour-tight covers with quick-release closures make easy access possible for cleaning and maintenance work. Manual disposal is carried out with the tank open. 20 year polyethylene warranty.

Variant

Direction of flow:	left
Disposal variant:	Standard
Shredder-Mix-System:	no
Nominal size (NS):	15,00
SonicControl:	no
Type of disposal:	manual with suction hose

General characteristics

Installation situation:	free-standing installation
Delivery state:	Installation-ready (connection parts must be connected on site)
ATEX:	no

Dimensions

Net weight:	355 kg
-------------	--------

Gross weight:	430 kg
Set-up area, length:	3530 mm
Set-up area, width:	1680 mm
Set-up area, height:	1950 mm
Required access area, length:	3530 mm
Required access area, width:	1490 mm
Required access area, height:	1950 mm
Packaging dimension:	length
Packaging dimension:	width
Packaging dimension:	height

Tank/drain body

Distance pipe bottom outlet to tank bottom:	1130 mm
Distance pipe bottom inlet to tank bottom:	1200 mm
Outlet nominal size (OD):	200 mm
Outlet nominal size (DN):	200 mm
Inlet nominal size (OD):	200 mm
Inlet nominal size (DN):	200 mm

Coverage features

Type of cover:	Cover
Cover material:	Polymer
Colour of cover:	violet
Tightness:	odour-tight

Wastewater contents

Separator contents:	2230 l
Max. grease layer thickness:	180 mm
Total volume:	3730 l
Contents of sludge trap:	1500 l
Storage quantity of grease:	600 l